

# CHENBRO



## User's Manual

### **SK51201** **1-to-2 2.5" SATA HDD** **Storage Kit**

### **Version A2**

**December / 10 / 2008**

## **Copyright**

Copyright © 2006 CHENBRO Micom Co., Ltd.. All rights reserved.

Unless otherwise indicated, all materials in this manual are copyrighted by CHENBRO Micom Co., Ltd.. All rights reserved. No part of this manual, either text or image may be used for any purpose other than internal use within purchasing company. Therefore, reproduction, modification in any form or by any means, electronic, mechanical or otherwise, for reasons other than internal use, is strictly prohibited without prior written permission.

CHENBRO Micom Co., Ltd. reserves the right to make improvement and modification to the products indicated in this manual at any time. Specifications are therefore subject to change without prior notice.

Information provided in this manual is intended to be accurate and reliable. However, CHENBRO Micom Co., Ltd., assumes no responsibility for its use, nor for any infringements upon the rights of third parties, which may result from its use.

## **Technical Support**

**CHENBRO works hard to offer our customers maximum performance from our chassis. But in case you have any problem with our product you can find supports from the following resources.**

### ***Web Support***

Detail information of our products is in our website. You can find technical updates, installation guides, FAQs, technical specifications and more. Our web address is: [www.chenbro.com](http://www.chenbro.com).

### ***Email Support***

You can also fill out the technical support form at our [Technical Support](#) page. Your technical issue inquiries will be sent directly to our support professionals.

### ***Phone Support***

**You can also contact CHENBRO HQ or branch office for immediate support; their contact information is as following:**

CHENBRO HQ	CHENBRO Europe B.V.	CHENBRO Micom (USA) Inc.
Tel: 886-2-8226-5500	Tel: 31-40-295-2045	Tel: 1-909-947-3200
Fax: 886-2-8226-5423	Fax: 31-40-295-2044	Fax : 1-909-947-4300

## **Contents**

<b>Copyright</b> .....	2
<b>Technical Support</b> .....	2
<b>Contents</b> .....	3
<b>Revision History</b> .....	4
<b>Safety Information</b> .....	5
<b>Conventions Used in this Manual</b> .....	5
<b>Getting Start with the SK51201 Storage Kit</b> .....	6
<b>Unpacking and Checking the Contents</b> .....	6
<b>Technical Specifications</b> .....	6
<b>Compatible CHENBRO Chassis</b> .....	6
<b>Introduction</b> .....	7
<b>Functional Specification</b> .....	7
<b>General</b> .....	7
<b>Host / Drive / Power Backplane Interface</b> .....	7
<b>Mechanical Dimension</b> .....	8
<b>Components Description</b> .....	9
<b>Front View</b> .....	9
<b>Rear View</b> .....	9
<b>Connector &amp; Switch Definition</b> .....	10
<b>HDD Failure Signal Connector</b> .....	10
<b>Setting for HDD Failure Signal Cable Connection (SK51201)</b> .....	10
<b>Setting for HDD Failure Signal Cable Connection (RAID Card)</b> .....	10
<b>Installation Procedures</b> .....	11
<b>Hot-swap HDD Assembly</b> .....	11

## Revision History

Date	Modifications
Dec. / 10 / 2008	● First Release

## **Safety Information**

- Read the installation instructions before connecting SK51201 to the power source.
- Only trained and qualified personnel should be allowed to install, replace or service this equipment.
- Never install this product in a wet environment.
- Position system cables and power cables carefully; route system cable and the power cable and plug so that they cannot be stepped on or tripped over. Be sure that nothing rests on your system components' cables or power cable.

## **Conventions Used in this Manual**

The following conventions are used in this manual.



**Important Icon:**





Provides important information on the current topic that must not be overlooked.

## Getting Start with the SK51201 Storage Kit

Thank you for purchasing SK51201! This section covers unpacking and identifying components.

### Unpacking and Checking the Contents

The complete SK51201 package includes the following items:

Item Description	Quantity	Picture
SK51201 storage cage	1	
Hot-swap 2.5" Hard Disk Drive (HDD) tray	2	
SATA cable, 700mm	2	
HDD failure signal cable, 2P to 2P, 600mm	1	
Screw: M3 (4mm) for HDD assembling	8	
Screw: M3 (5mm) for storage cage and chassis assembling	4	

## Technical Specifications

Occupancy	1 x 3.5" Drive Bay
Capacity	2 x 2.5" SATA Hot-swap HDDs
Dimension (WxHxD)	101.6 x 25.4 x 142.8 (mm) 4 x 1 x 5.6 (inch)
Weight	340 g

## Compatible CHENBRO Chassis

- RM21600 / RM21706 / RM22300 / RM22500  
RM31212B / RM31300 / RM31408  
RM41100 / RM41416B / RM41500 / RM42200  
RM51224B / RM51424 / RM51924B
- SR107 / SR108 / SR109 / SR110 / SR111 / SR201 / SR214
- PC303 / PC308 / PC310 / PC405  
PC602 / PC611 / PC613 / PC617  
PC710 / PC711 / PC805 / PC806

## Introduction

The CHENBRO SK51201 can house two Hot-swap 2.5" SATA HDD in one 3.5" bay converter. The ability for conversion allows existing server or PC to perform with one Hot-swap HDD and keep the flexibility. In all, SK51201 is the best solution as value added feature and performance.

## Functional Specification

### *General*

- Support up to SATA-II (3.0 Gb/s)
- Compatible with 2.5" SATA HDD (9.5 mm height)
- Support inrush current control for HDD Hot-swapping
- LED indicate activity and failure

### *Host / Drive / Power Backplane Interface*

- 2 to 2 connection for 2.5" SATA HDD
- 2 x SATA / SAS Signal + Power (7+15 pin) connector at HDD side of backplane
- 2 x SATA / SAS interface (7 pin)
- 1 x DC power connectors (4-pin FDD power connector)



SK51201 supports **9.5 mm high 2.5" HDD** only



The HDD activity LDE is available for SATA-II HDDs.  
If SATA-I HDD applied, the HDD activity LED will not work.

## Mechanical Dimension

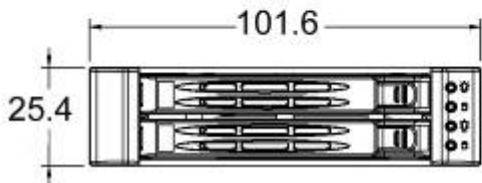
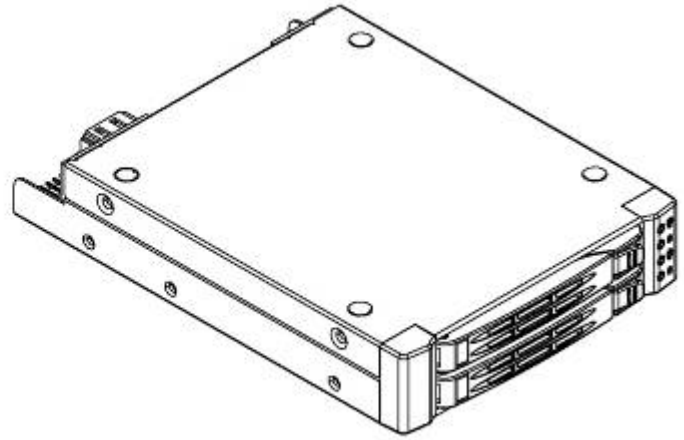
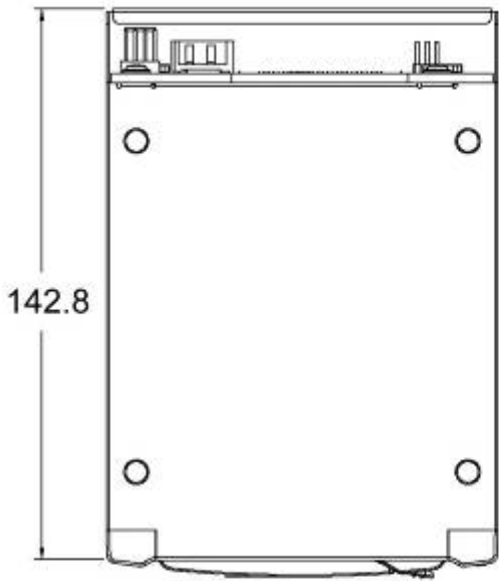

Units: mm



## Components Description

### Front View



	Device	Function
1	2.5" HDD Hot-swap Trays	Refer to Page 11
2	HDD Power LED	Blue LED On - HDD Power On
3	HDD activity / failure LED	Green LED On - HDD active Red LED On - HDD failure

### Rear View



	Device	Function
1	SATA Connectors	Connect to motherboard / RAID card
2	HDD failure signal connector	Refer to Page 10
3	HDD Access signal connector	Reserved for HDD Access signal
4	Power Connector	Power input

## Connector & Switch Definition

### **HDD Failure Signal Connector**

This connector is for the SAS / SATA RAID card with HDD failure signal support such as LSI MegaRAID 8308ELP. Connect the 2-pin cable on SK51201 backplane and RAID card to activate the HDD failure LED.

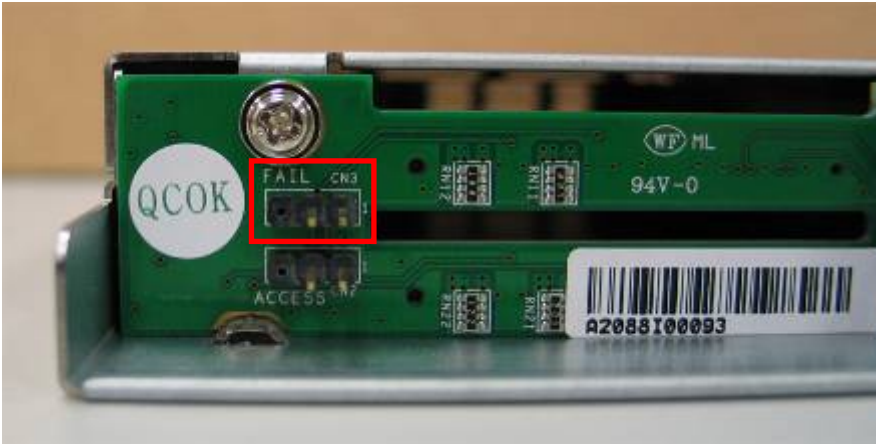

### **Setting for HDD Failure Signal Cable Connection (SK51201)**



HDD Failure Signal Cable:  
26H115311-001

### **Setting for HDD Failure Signal Cable Connection (RAID Card)**

Connect the yellow wire of the cable to the CATHODE of the HDD failure connector on RAID card.  
Refer to your RAID card's user manual for the detailed pin definition.

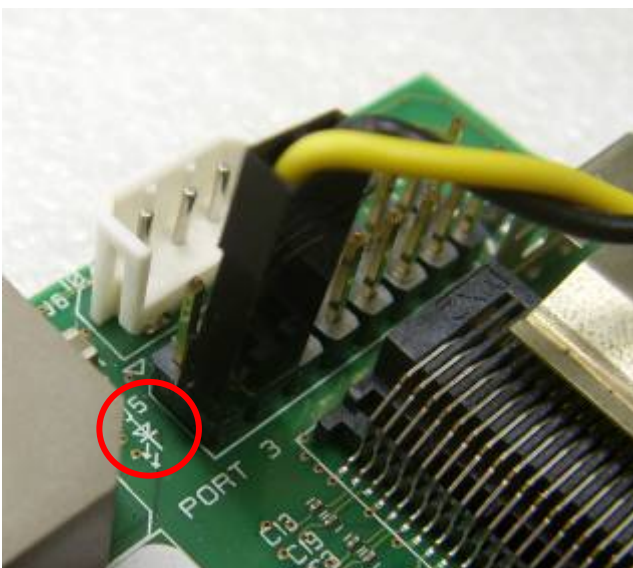

## Installation Procedures

The following is the installation procedures of HDD assembly.

### *Hot-swap HDD Assembly*

- a. Push the blue latch of HDD tray



- b. Pull it out from the cage



- c. Remove the supporter

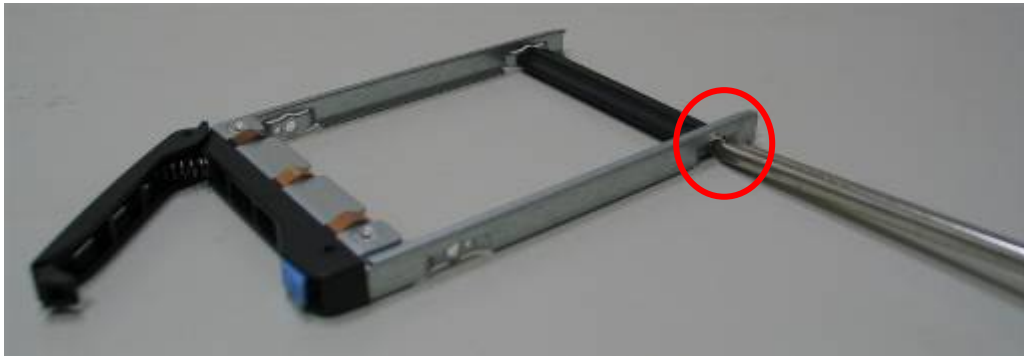

d. Attach HDD with four screws per tray



e. Insert HDD tray to the cage

